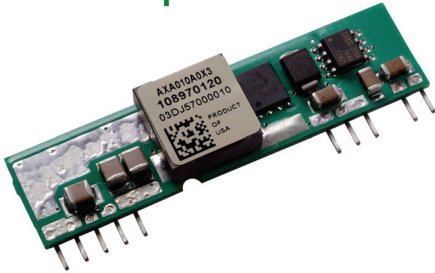


## Austin Lynx™ SIP Non-isolated Power Modules, Programmable: 3Vdc – 5.5Vdc input; 0.75Vdc to 3.63Vdc Output; 10A Output Current

### RoHS Compliant



### Applications

- Distributed power architectures
- Intermediate bus voltage applications
- Telecommunications equipment
- Servers and storage applications
- Networking equipment
- Enterprise Networks
- Latest generation IC's (DSP, FPGA, ASIC) and Microprocessor powered applications

### Description

Austin Lynx™ SIP power modules are non-isolated dc-dc converters that can deliver up to 10A of output current with full load efficiency of 95% at 3.3V output. These modules provide a precisely regulated output voltage programmable via an external resistor from 0.75Vdc to 3.63Vdc over a wide range of input voltage ( $V_{IN} = 3.0 - 5.5Vdc$ ). Their open-frame construction and small footprint enable designers to develop cost- and space-efficient solutions.

### Features

- Compliant to RoHS EU Directive 2002/95/EC (-Z versions)
- Compliant to ROHS EU Directive 2002/95/EC with lead solder exemption (non-Z versions)
- Delivers up to 10A output current
- High efficiency – 95% at 3.3V full load ( $V_{IN} = 5.0V$ )
- Small size and low profile:  
50.8 mm x 12.7 mm x 8.10 mm  
(2.00 in x 0.5 in x 0.32 in)
- Low output ripple and noise
- High Reliability:  
Calculated MTBF = 15.7 M hours at 25°C Full-load
- Constant switching frequency (300 kHz)
- Output voltage programmable from 0.75 Vdc to 3.63Vdc via external resistor
- Line Regulation: 0.3% (typical)
- Load Regulation: 0.4% (typical)
- Temperature Regulation: 0.4 % (typical)
- Remote On/Off
- Remote Sense
- Over temperature protection
- Output overcurrent protection (non-latching)
- Wide operating temperature range (-40°C to 85°C)
- UL\* 60950-1 Recognized, CSA† C22.2 No. 60950-1-03 Certified, and VDE‡ 0805:2001-12 (EN60950-1) Licensed
- ISO\*\* 9001 and ISO 14001 certified manufacturing facilities

\* UL is a registered trademark of Underwriters Laboratories, Inc.

† CSA is a registered trademark of Canadian Standards Association.

‡ VDE is a trademark of Verband Deutscher Elektrotechniker e.V.

\*\* ISO is a registered trademark of the International Organization of Standards

## Absolute Maximum Ratings

Stresses in excess of the absolute maximum ratings can cause permanent damage to the device. These are absolute stress ratings only, functional operation of the device is not implied at these or any other conditions in excess of those given in the operations sections of the data sheet. Exposure to absolute maximum ratings for extended periods can adversely affect the device reliability.

Parameter	Device	Symbol	Min	Max	Unit
Input Voltage Continuous	All	$V_{IN}$	-0.3	5.8	Vdc
Operating Ambient Temperature (see Thermal Considerations section)	All	$T_A$	-40	85	°C
Storage Temperature	All	$T_{stg}$	-55	125	°C

## Electrical Specifications

Unless otherwise indicated, specifications apply over all operating input voltage, resistive load, and temperature conditions.

Parameter	Device	Symbol	Min	Typ	Max	Unit
Operating Input Voltage	All	$V_{IN}$	3.0		5.5	Vdc
Maximum Input Current ( $V_{IN} = V_{IN, min}$ to $V_{IN, max}$ ; $I_O = I_{O, max}$ ; $V_{O, set} = 3.3Vdc$ )	All	$I_{IN, max}$			10	Adc
Input No Load Current ( $V_{IN} = 5.0Vdc$ ; $I_O = 0$ ; module enabled)	$V_{O, set} = 0.75Vdc$	$I_{IN, No load}$		25		mA
	$V_{O, set} = 3.3Vdc$	$I_{IN, No load}$		30		mA
Input Stand-by Current ( $V_{IN} = 5.0Vdc$ ; module disabled)	All	$I_{IN, stand-by}$		1.5		mA
Inrush Transient	All	$I^2t$			0.1	A <sup>2</sup> s
Input Reflected Ripple Current, peak-to-peak (5Hz to 20MHz, 1μH source impedance; $V_{IN, min}$ to $V_{IN, max}$ ; $I_O = I_{O, max}$ ; See Test configuration section)	All			100		mAp-p
Input Ripple Rejection (120Hz)	All			30		dB

**CAUTION: This power module is not internally fused. An input line fuse must always be used.**

This power module can be used in a wide variety of applications, ranging from simple standalone operation to being part of a complex power architecture. To preserve maximum flexibility, internal fusing is not included, however, to achieve maximum safety and system protection, always use an input line fuse. The safety agencies require a 15A, time-delay fuse (see Safety Considerations section). Based on the information provided in this data sheet on inrush energy and maximum dc input current, the same type of fuse with a lower rating can be used. Refer to the fuse manufacturer's data sheet for further information.

### Electrical Specifications (continued)

Parameter	Device	Symbol	Min	Typ	Max	Unit
Output Voltage Set-point ( $V_{IN}=V_{IN, min}$ , $I_O=I_{O, max}$ , $T_A=25^\circ\text{C}$ )	All	$V_{O, set}$	-2.0	$V_{O, set}$	+2.0	% $V_{O, set}$
Output Voltage (Over all operating input voltage, resistive load, and temperature conditions until end of life)	All	$V_{O, set}$	-3.0%	—	+3%	% $V_{O, set}$
Adjustment Range Selected by an external resistor	All	$V_O$	0.7525		3.63	Vdc
Output Regulation Line ( $V_{IN}=V_{IN, min}$ to $V_{IN, max}$ )	All		—	0.3	—	% $V_{O, set}$
Load ( $I_O=I_{O, min}$ to $I_{O, max}$ )	All		—	0.4	—	% $V_{O, set}$
Temperature ( $T_{ref}=T_{A, min}$ to $T_{A, max}$ )	All		—	0.4	—	% $V_{O, set}$
Output Ripple and Noise on nominal output ( $V_{IN}=V_{IN, nom}$ and $I_O=I_{O, min}$ to $I_{O, max}$ Cout = 1 $\mu\text{F}$ ceramic//10 $\mu\text{F}$ tantalum capacitors)						
RMS (5Hz to 20MHz bandwidth)	All		—	8	15	mV <sub>rms</sub>
Peak-to-Peak (5Hz to 20MHz bandwidth)	All		—	25	50	mV <sub>pk-pk</sub>
External Capacitance ESR $\geq$ 1 m $\Omega$	All	$C_{O, max}$	—	—	1000	$\mu\text{F}$
ESR $\geq$ 10 m $\Omega$	All	$C_{O, max}$	—	—	5000	$\mu\text{F}$
Output Current	All	$I_O$	0		10	Adc
Output Current Limit Inception (Hiccup Mode ) ( $V_O=90\%$ of $V_{O, set}$ )	All	$I_{O, lim}$	—	200	—	% $I_O$
Output Short-Circuit Current ( $V_O \leq 250\text{mV}$ ) ( Hiccup Mode )	All	$I_{O, s/c}$	—	3	—	Adc
Efficiency $V_{IN} = V_{IN, nom}$ , $T_A=25^\circ\text{C}$ $I_O=I_{O, max}$ , $V_O=V_{O, set}$	$V_{O, set} = 0.75\text{Vdc}$	$\eta$		82.5		%
	$V_{O, set} = 1.2\text{Vdc}$	$\eta$		88.0		%
	$V_{O, set} = 1.5\text{Vdc}$	$\eta$		89.5		%
	$V_{O, set} = 1.8\text{Vdc}$	$\eta$		91.0		%
	$V_{O, set} = 2.5\text{Vdc}$	$\eta$		93.0		%
	$V_{O, set} = 3.3\text{Vdc}$	$\eta$		95.0		%
Switching Frequency	All	$f_{sw}$	—	300	—	kHz
Dynamic Load Response ( $dI_O/dt=2.5\text{A}/\mu\text{s}$ ; $V_{IN} = V_{IN, nom}$ ; $T_A=25^\circ\text{C}$ ) Load Change from $I_O=50\%$ to $100\%$ of $I_{O, max}$ ; 1 $\mu\text{F}$ ceramic// 10 $\mu\text{F}$ tantalum Peak Deviation	All	$V_{pk}$	—	200	—	mV
Settling Time ( $V_O < 10\%$ peak deviation)	All	$t_s$	—	25	—	$\mu\text{s}$
( $dI_O/dt=2.5\text{A}/\mu\text{s}$ ; $V_{IN} = V_{IN, nom}$ ; $T_A=25^\circ\text{C}$ ) Load Change from $I_O=100\%$ to $50\%$ of $I_{O, max}$ : 1 $\mu\text{F}$ ceramic// 10 $\mu\text{F}$ tantalum Peak Deviation	All	$V_{pk}$	—	200	—	mV
Settling Time ( $V_O < 10\%$ peak deviation)	All	$t_s$	—	25	—	$\mu\text{s}$

### Electrical Specifications (continued)

Parameter	Device	Symbol	Min	Typ	Max	Unit
Dynamic Load Response (dI <sub>O</sub> /dt=2.5A/μs; V <sub>IN</sub> = V <sub>IN, nom</sub> ; T <sub>A</sub> =25°C) Load Change from I <sub>O</sub> = 50% to 100% of I <sub>O,max</sub> ; C <sub>O</sub> = 2x150 μF polymer capacitors Peak Deviation	All	V <sub>pk</sub>	—	100	—	mV
Settling Time (V <sub>O</sub> <10% peak deviation)	All	t <sub>s</sub>	—	100	—	μs
(dI <sub>O</sub> /dt=2.5A/μs; V <sub>IN</sub> = V <sub>IN, nom</sub> ; T <sub>A</sub> =25°C) Load Change from I <sub>O</sub> = 100% to 50% of I <sub>O,max</sub> ; C <sub>O</sub> = 2x150 μF polymer capacitors Peak Deviation	All	V <sub>pk</sub>	—	100	—	mV
Settling Time (V <sub>O</sub> <10% peak deviation)	All	t <sub>s</sub>	—	100	—	μs

### General Specifications

Parameter	Min	Typ	Max	Unit
Calculated MTBF (I <sub>O</sub> =I <sub>O, max</sub> , T <sub>A</sub> =25°C) Telecordia SR-332 Issue 1: Method 1 Case 3		15,726,000		Hours
Weight	—	5.6 (0.2)	—	g (oz.)

## Feature Specifications

Unless otherwise indicated, specifications apply over all operating input voltage, resistive load, and temperature conditions. See Feature Descriptions for additional information.

Parameter	Device	Symbol	Min	Typ	Max	Unit
Remote On/Off Signal interface ( $V_{IN}=V_{IN, min}$ to $V_{IN, max}$ ; Open collector pnp or equivalent Compatible, Von/off signal referenced to GND See feature description section)						
Logic High						
Input High Voltage (Module OFF)	All	$V_{IH}$	1.5	—	$V_{IN, max}$	V
Input High Current	All	$I_{IH}$	—	0.2	1	mA
Logic Low						
Input Low Voltage (Module ON)	All	$V_{IL}$	-0.2	—	0.3	V
Input Low Current	All	$I_{IL}$	—	—	10	$\mu$ A
Turn-On Delay and Rise Times ( $I_O=I_{O, max}$ , $V_{IN}=V_{IN, nom}$ , $T_A = 25^\circ\text{C}$ )						
Case 1: On/Off input is set to Logic Low (Module ON) and then input power is applied (delay from instant at which $V_{IN} = V_{IN, min}$ until $V_O=10\%$ of $V_{O, set}$ )	All	Tdelay	—	3.9	—	msec
Case 2: Input power is applied for at least one second and then the On/Off input is set to logic Low (delay from instant at which Von/Off=0.3V until $V_O=10\%$ of $V_{O, set}$ )	All	Tdelay	—	3.9	—	msec
Output voltage Rise time (time for $V_O$ to rise from 10% of $V_{O, set}$ to 90% of $V_{O, set}$ )	All	Trise	—	4.2	8.5	msec
Output voltage overshoot – Startup ( $I_O= I_{O, max}$ ; $V_{IN} = 3.0$ to $5.5\text{Vdc}$ , $T_A = 25^\circ\text{C}$ )				—	1	% $V_{O, set}$
Remote Sense Range			—	—	0.5	V
Overtemperature Protection (See Thermal Consideration section)	All	$T_{ref}$	—	125	—	$^\circ\text{C}$
Input Undervoltage Lockout						
Turn-on Threshold	All			2.2		V
Turn-off Threshold	All			2.0		V

### Characteristic Curves

The following figures provide typical characteristics for the Austin Lynx™ SIP modules at 25°C.

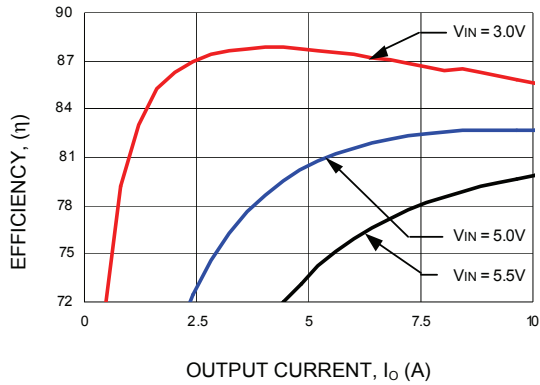


Figure 1. Converter Efficiency versus Output Current (Vout = 0.75Vdc).

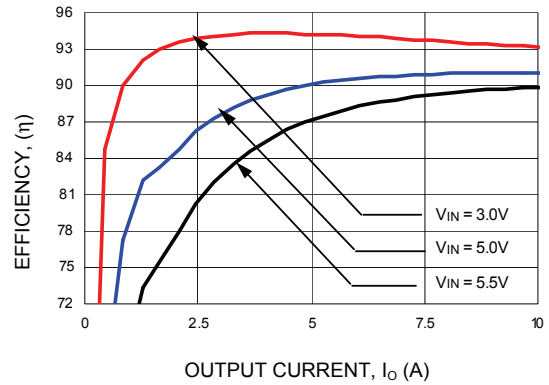


Figure 4. Converter Efficiency versus Output Current (Vout = 1.8Vdc).

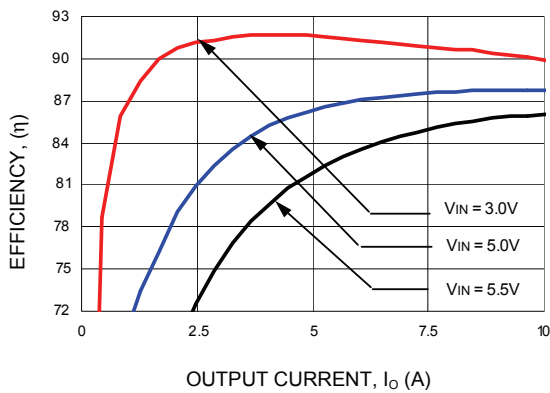


Figure 2. Converter Efficiency versus Output Current (Vout = 1.2Vdc).

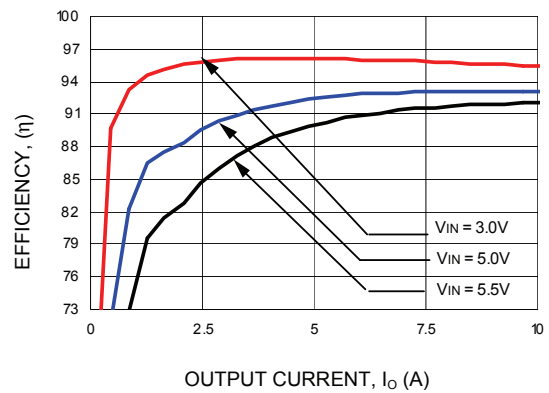


Figure 5. Converter Efficiency versus Output Current (Vout = 2.5Vdc).

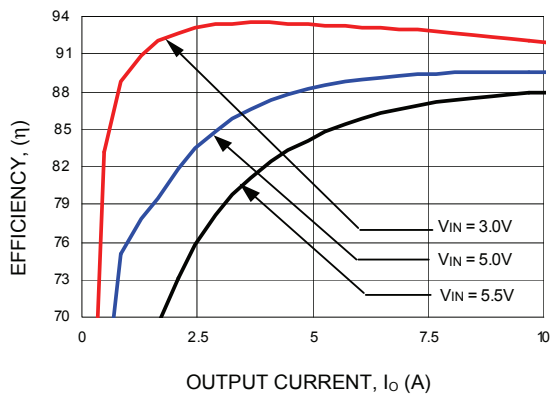


Figure 3. Converter Efficiency versus Output Current (Vout = 1.5Vdc).

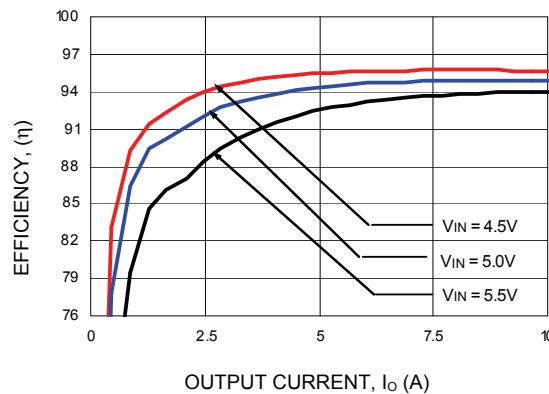
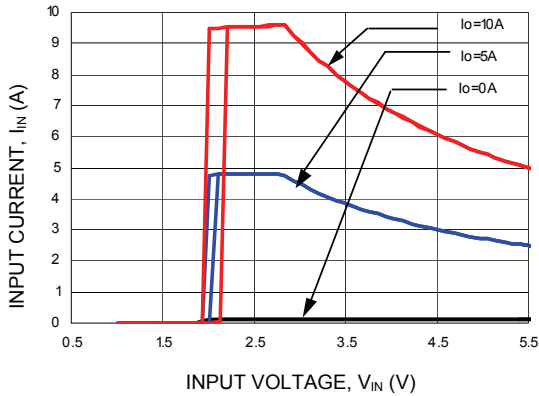


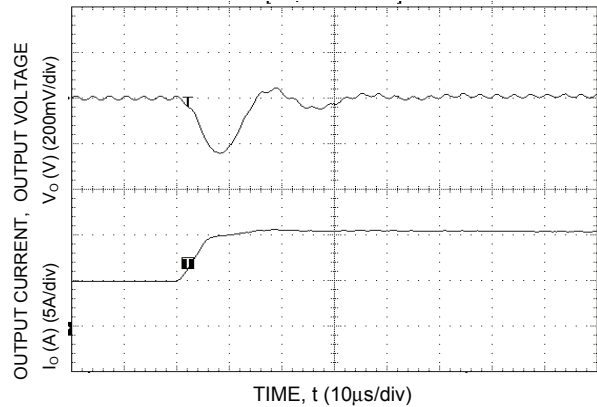
Figure 6. Converter Efficiency versus Output Current (Vout = 3.3Vdc).

**Characteristic Curves** (continued)

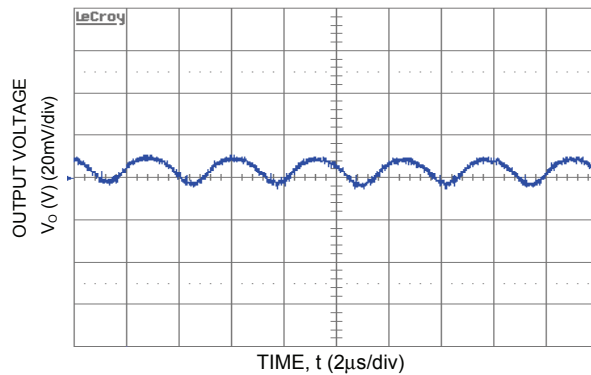
The following figures provide typical characteristics for the Austin Lynx™ SIP modules at 25°C.



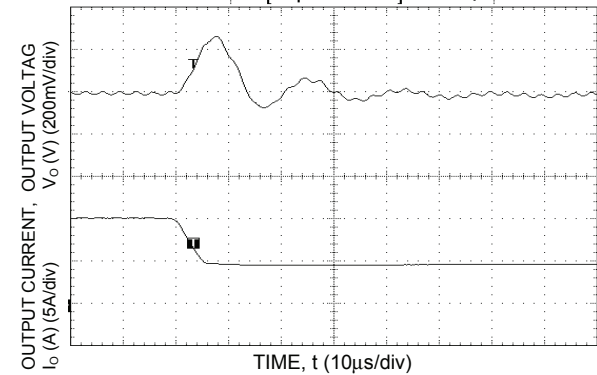
**Figure 7. Input voltage vs. Input Current ( $V_o = 2.5Vdc$ ).**



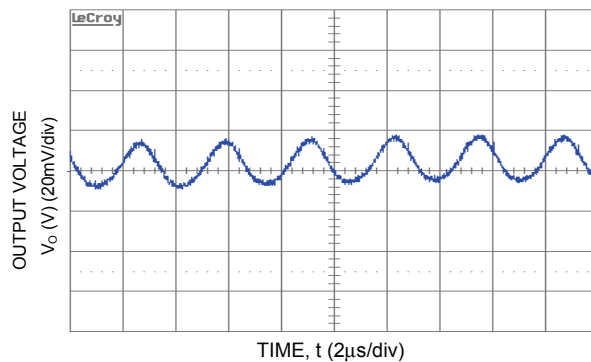
**Figure 10. Transient Response to Dynamic Load Change from 50% to 100% of full load ( $V_o = 3.3Vdc$ ).**



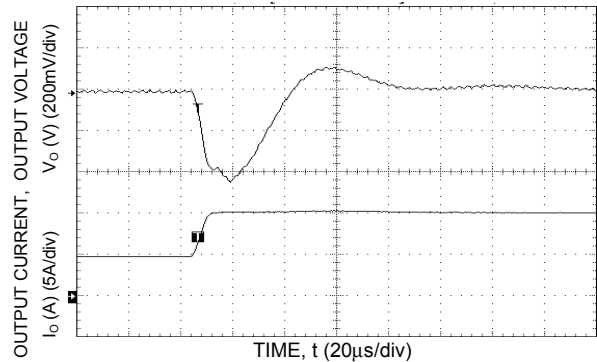
**Figure 8. Typical Output Ripple and Noise ( $V_{in} = 5.0V$  dc,  $V_o = 0.75Vdc$ ,  $I_o = 10A$ ).**



**Figure 11. Transient Response to Dynamic Load Change from 100% to 50% of full load ( $V_o = 3.3 Vdc$ ).**



**Figure 9. Typical Output Ripple and Noise ( $V_{in} = 5.0V$  dc,  $V_o = 3.3 Vdc$ ,  $I_o = 10A$ ).**



**Figure 12. Transient Response to Dynamic Load Change from 50% to 100% of full load ( $V_o = 3.3 Vdc$ ,  $C_{ext} = 2 \times 150 \mu F$  Polymer Capacitors).**

Characteristic Curves (continued)

The following figures provide typical characteristics for the Austin Lynx™ SMT modules at 25°C.

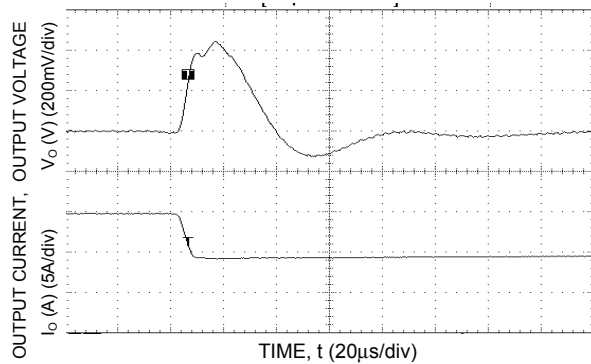


Figure 13. Transient Response to Dynamic Load Change from 100% of 50% full load ( $V_o = 3.3\text{ Vdc}$ ,  $C_{ext} = 2 \times 150\ \mu\text{F}$  Polymer Capacitors).

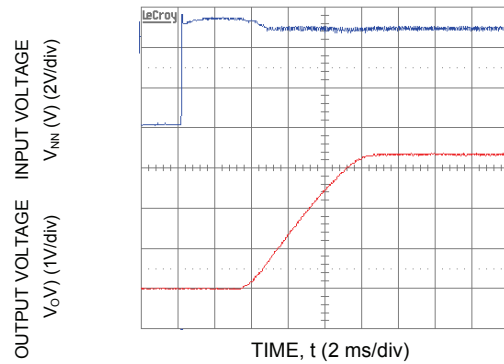


Figure 16. Typical Start-Up with application of  $V_{in}$  ( $V_{in} = 5.5\text{Vdc}$ ,  $V_o = 3.3\text{Vdc}$ ,  $I_o = 10\text{A}$ ).

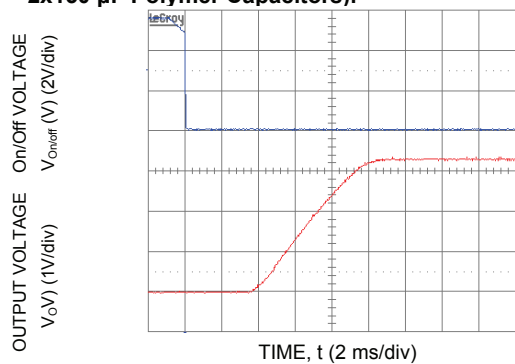


Figure 14. Typical Start-Up Using Remote On/Off ( $V_{in} = 5.0\text{Vdc}$ ,  $V_o = 3.3\text{Vdc}$ ,  $I_o = 10.0\text{A}$ ).

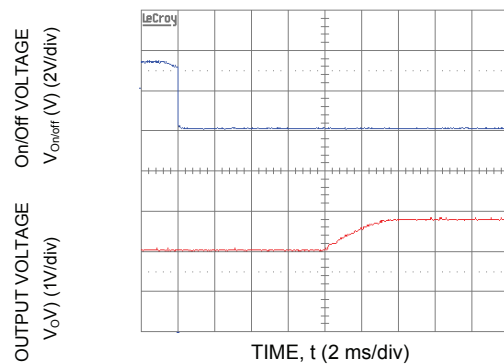


Figure 17 Typical Start-Up Using Remote On/Off with Prebias ( $V_{in} = 3.3\text{Vdc}$ ,  $V_o = 1.8\text{Vdc}$ ,  $I_o = 1.0\text{A}$ ,  $V_{bias} = 1.0\text{Vdc}$ ).

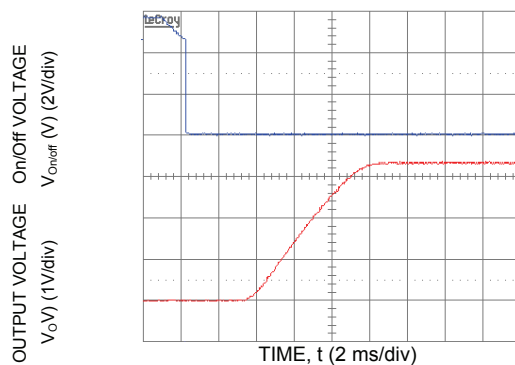


Figure 15. Typical Start-Up Using Remote On/Off with Low-ESR external capacitors ( $V_{in} = 5.5\text{Vdc}$ ,  $V_o = 3.3\text{Vdc}$ ,  $I_o = 10.0\text{A}$ ,  $C_o = 1050\ \mu\text{F}$ ).

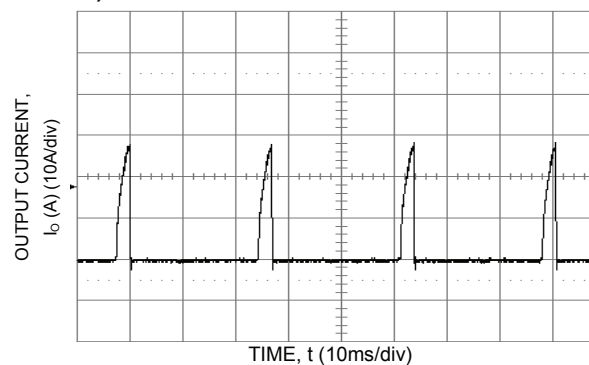
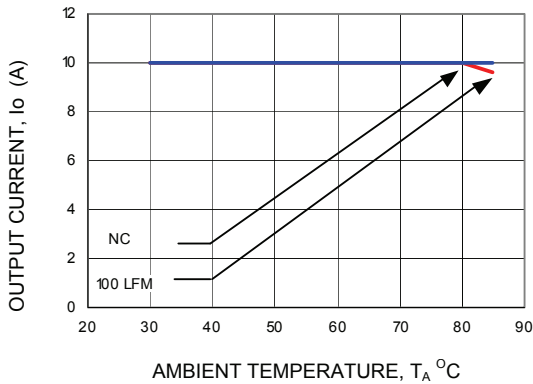


Figure 18. Output short circuit Current ( $V_{in} = 5.0\text{Vdc}$ ,  $V_o = 0.75\text{Vdc}$ ).

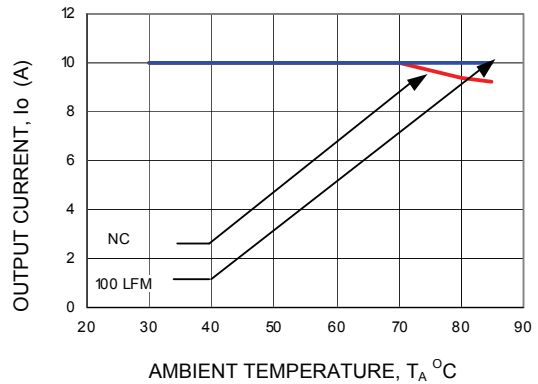


**Characteristic Curves** (continued)

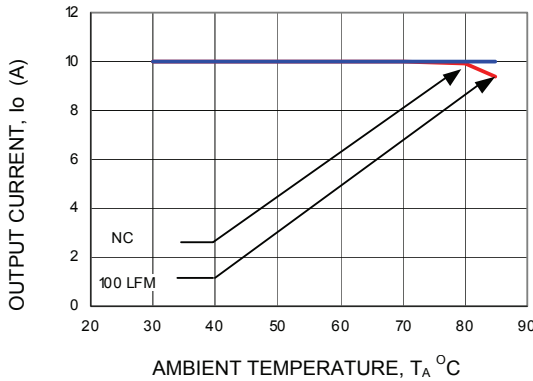
The following figures provide thermal derating curves for the Austin Lynx™ SIP modules.



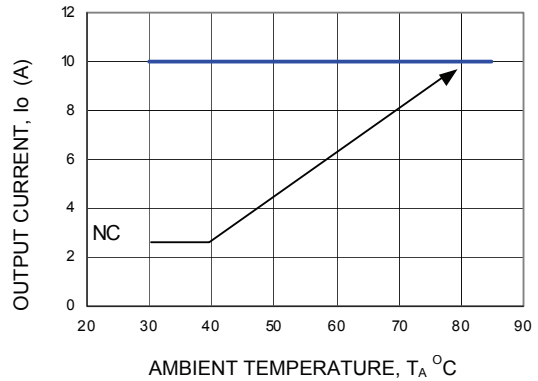
**Figure 19. Derating Output Current versus Local Ambient Temperature and Airflow ( $V_{in} = 5.0Vdc$ ,  $V_o=0.75Vdc$ ).**



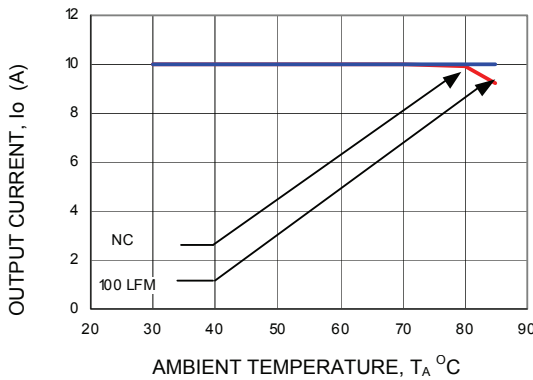
**Figure 22. Derating Output Current versus Local Ambient Temperature and Airflow ( $V_{in} = 5.0Vdc$ ,  $V_o=3.3 Vdc$ ).**



**Figure 20. Derating Output Current versus Local Ambient Temperature and Airflow ( $V_{in} = 5.0Vdc$ ,  $V_o=1.8 Vdc$ ).**

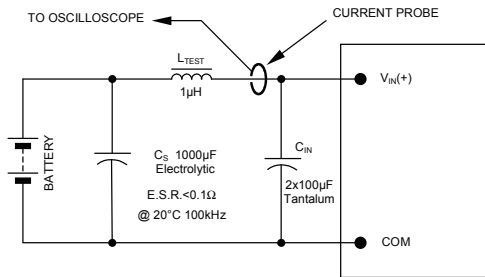


**Figure 23. Derating Output Current versus Local Ambient Temperature and Airflow ( $V_{in} = 3.3Vdc$ ,  $V_o=2.5 Vdc$ ).**



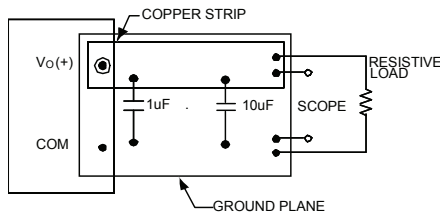
**Figure 21. Derating Output Current versus Local Ambient Temperature and Airflow ( $V_{in} = 5.0Vdc$ ,  $V_o=2.5 Vdc$ ).**

## Test Configurations



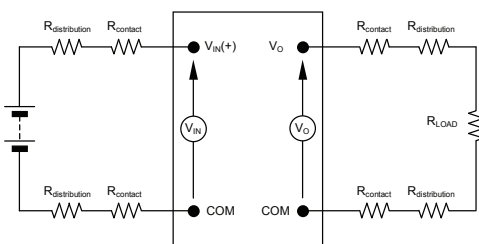
NOTE: Measure input reflected ripple current with a simulated source inductance ( $L_{TEST}$ ) of 1µH. Capacitor  $C_S$  offsets possible battery impedance. Measure current as shown above.

Figure 24. Input Reflected Ripple Current Test Setup.



NOTE: All voltage measurements to be taken at the module terminals, as shown above. If sockets are used then Kelvin connections are required at the module terminals to avoid measurement errors due to socket contact resistance.

Figure 25. Output Ripple and Noise Test Setup.



NOTE: All voltage measurements to be taken at the module terminals, as shown above. If sockets are used then Kelvin connections are required at the module terminals to avoid measurement errors due to socket contact resistance.

Figure 26. Output Voltage and Efficiency Test Setup.

$$\text{Efficiency } \eta = \frac{V_o \cdot I_o}{V_{IN} \cdot I_{IN}} \times 100 \%$$

## Design Considerations

### Input Filtering

Austin Lynx™ SIP module should be connected to a low-impedance source. A highly inductive source can affect the stability of the module. An input capacitance must be placed directly adjacent to the input pin of the module, to minimize input ripple voltage and ensure module stability.

To minimize input voltage ripple, low-ESR polymer and ceramic capacitors are recommended at the input of the module. Figure 27 shows input ripple voltage (mVp-p) for various outputs with 1x150 µF polymer capacitors (Panasonic p/n: EEFUE0J151R, Sanyo p/n: 6TPE150M) in parallel with 1 x 47 µF ceramic capacitor (Panasonic p/n: ECJ-5YB0J476M, Taiyo- Yuden p/n: CEJMK432BJ476MMT) at full load. Figure 28 shows the input ripple with 3x150 µF polymer capacitors in parallel with 2 x 47 µF ceramic capacitor at full load.

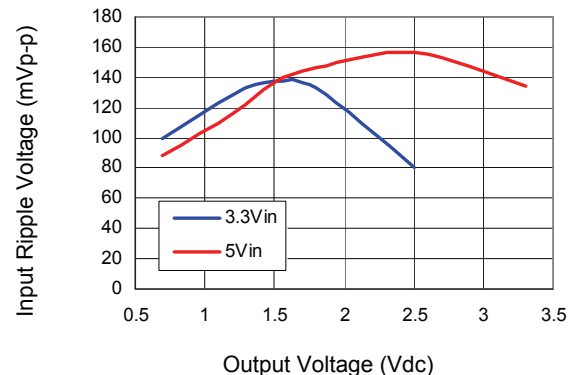


Figure 27. Input ripple voltage for various output with 1x150 µF polymer and 1x47 µF ceramic capacitors at the input (full load).

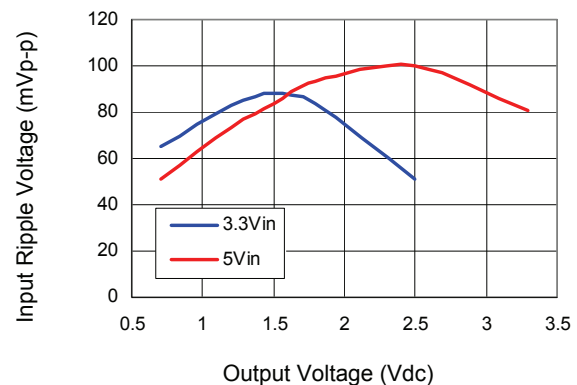


Figure 28. Input ripple voltage for various output with 3x150 µF polymer and 2x47 µF ceramic capacitors at the input (full load)

## Design Considerations (continued)

### Output Filtering

The Austin Lynx™ SIP module is designed for low output ripple voltage and will meet the maximum output ripple specification with 1  $\mu$ F ceramic and 10  $\mu$ F tantalum capacitors at the output of the module. However, additional output filtering may be required by the system designer for a number of reasons. First, there may be a need to further reduce the output ripple and noise of the module. Second, the dynamic response characteristics may need to be customized to a particular load step change.

To reduce the output ripple and improve the dynamic response to a step load change, additional capacitance at the output can be used. Low ESR polymer and ceramic capacitors are recommended to improve the dynamic response of the module. For stable operation of the module, limit the capacitance to less than the maximum output capacitance as specified in the electrical specification table.

## Safety Considerations

For safety agency approval the power module must be installed in compliance with the spacing and separation requirements of the end-use safety agency standards, i.e., UL 60950-1, CSA C22.2 No. 60950-1-03, and VDE 0850:2001-12 (EN60950-1) Licensed.

For the converter output to be considered meeting the requirements of safety extra-low voltage (SELV), the input must meet SELV requirements. The power module has extra-low voltage (ELV) outputs when all inputs are ELV.

The input to these units is to be provided with a fast-acting fuse with a maximum rating of 15A in the positive input lead.

## Feature Description

### Remote On/Off

The Austin Lynx™ power modules feature an On/Off pin for remote On/Off operation. The On/Off pin is pulled high with an external pull-up resistor (typical  $R_{pull-up} = 68k, \pm 5\%$ ) as shown in Fig. 28. When transistor Q1 is in the Off state, logic High is applied to the On/Off pin and the power module is Off. The minimum On/off voltage for logic High on the On/Off pin is 1.5Vdc. To turn the module ON, logic Low is applied to the On/Off pin by turning ON Q1. When not using the negative logic On/Off, leave the pin unconnected or tie to GND.

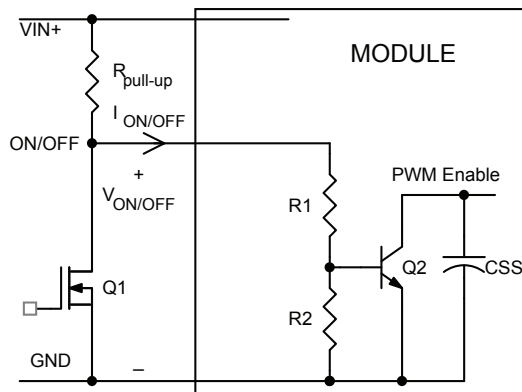


Figure 29. Circuit configuration for using positive logic On/Off.

### Overcurrent Protection

To provide protection in a fault (output overload) condition, the unit is equipped with internal current-limiting circuitry and can endure current limiting continuously. At the point of current-limit inception, the unit enters hiccup mode. The unit operates normally once the output current is brought back into its specified range. The typical average output current during hiccup is 3A.

### Input Undervoltage Lockout

At input voltages below the input undervoltage lockout limit, module operation is disabled. The module will begin to operate at an input voltage above the undervoltage lockout turn-on threshold.

### Overtemperature Protection

To provide protection in a fault condition, the unit is equipped with a thermal shutdown circuit. The unit will shutdown if the thermal reference point  $T_{ref}$ , exceeds 125°C (typical), but the thermal shutdown is not intended as a guarantee that the unit will survive temperatures beyond its rating. The module will automatically restarts after it cools down.

### Output Voltage Programming

The output voltage of the Austin Lynx™ SIP can be programmed to any voltage from 0.75 Vdc to 3.3 Vdc by connecting a single resistor (shown as  $R_{trim}$  in Figure 31) between the TRIM and GND pins of the module. Without an external resistor between the TRIM pin and the ground, the output voltage of the module is 0.7525 Vdc. To calculate the value of the resistor  $R_{trim}$  for a particular output voltage  $V_o$ , use the following equation:

$$R_{trim} = \left[ \frac{21070}{V_o - 0.7525} - 5110 \right] \Omega$$

For example, to program the output voltage of the Austin Lynx™ module to 1.8 Vdc,  $R_{trim}$  is calculated as follows:

$$R_{trim} = \left[ \frac{21070}{1.8 - 0.7525} - 5110 \right] \Omega$$

$$R_{trim} = 15.004k\Omega$$

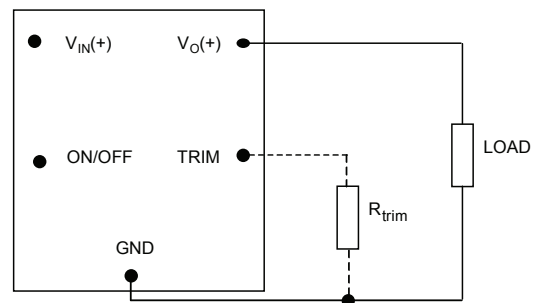


Figure 31. Circuit configuration for programming output voltage using an external resistor.

Table 1 provides  $R_{trim}$  values for some common output voltages

Table 1

$V_{o, set} (V)$	$R_{trim} (K\Omega)$
0.7525	Open
1.2	41.973
1.5	23.077
1.8	15.004
2.5	6.947
3.3	3.160

By using a 1% tolerance trim resistor, set point tolerance of  $\pm 2\%$  is achieved as specified in the electrical specifications. The POL Programming Tool, available at [www.lineagepower.com](http://www.lineagepower.com) under the Design Tools section, helps determine the required external trim resistor needed for a specific output voltage

### Feature Descriptions (continued)

The amount of power delivered by the module is defined as the voltage at the output terminals multiplied by the output current. When using the trim feature, the output voltage of the module can be increased, which at the same output current would increase the power output of the module. Care should be taken to ensure that the maximum output power of the module remains at or below the maximum rated power ( $P_{max} = V_{o,set} \times I_{o,max}$ ).

### Voltage Margining

Output voltage margining can be implemented in the Austin Lynx™ modules by connecting a resistor,  $R_{margin-up}$ , from the Trim pin to the ground pin for margining-up the output voltage and by connecting a resistor,  $R_{margin-down}$ , from the Trim pin to the Output pin for margining-down. Figure 32 shows the circuit configuration for output voltage margining. The POL Programming Tool, available at [www.lineagepower.com](http://www.lineagepower.com) under the Design Tools section, also calculates the values of  $R_{margin-up}$  and  $R_{margin-down}$  for a specific output voltage and % margin. Please consult your local Lineage Power technical representative for additional details.

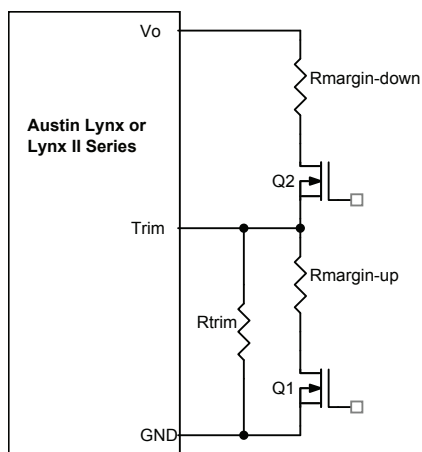


Figure 32. Circuit Configuration for margining Output voltage.

### Remote Sense

The Austin Lynx™ SIP power modules have a Remote Sense feature to minimize the effects of distribution losses by regulating the voltage at the Remote Sense pin (See Figure 33). The voltage between the Sense pin and  $V_o$  pin must not exceed 0.5V.

The amount of power delivered by the module is defined as the output voltage multiplied by the output current

( $V_o \times I_o$ ). When using Remote Sense, the output voltage of the module can increase, which if the same output is maintained, increases the power output by the module. Make sure that the maximum output power of the module remains at or below the maximum rated power. When the Remote Sense feature is not being used, leave the Remote Sense pin unconnected.

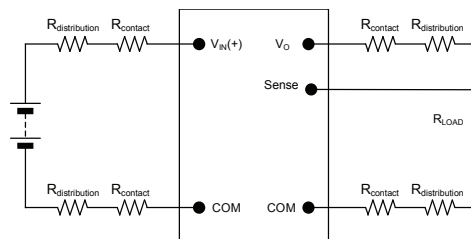


Figure 33. Remote sense circuit configuration

### Thermal Considerations

The power modules operate in a variety of thermal environments; however, sufficient cooling should always be provided to help ensure reliable operation.

Considerations include ambient temperature, airflow, module power dissipation, and the need for increased reliability. A reduction in the operating temperature of the module will result in an increase in reliability. The thermal data presented here is based on physical measurements taken in a wind tunnel. The test set-up is shown in Figure 34. Note that the airflow is parallel to the long axis of the module as shown in Figure 35. The derating data applies to airflow in either direction of the module's long axis.

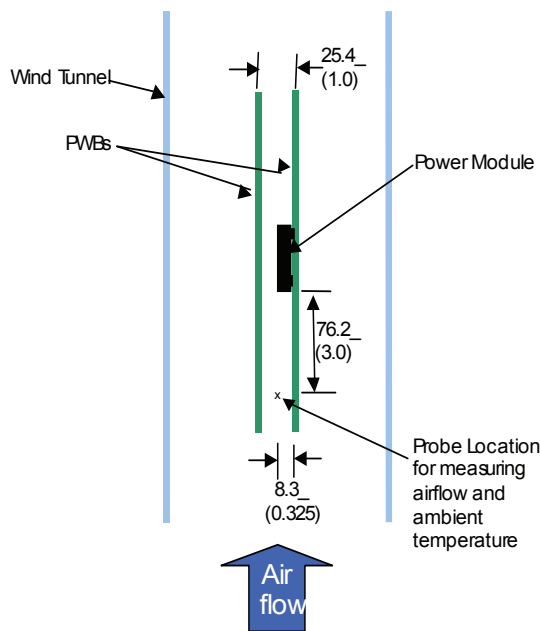


Figure 35. Thermal Test Set-up.

The thermal reference point,  $T_{ref}$  used in the specifications is shown in Figure 34. For reliable operation this temperature should not exceed 125 °C. The output power of the module should not exceed the rated power of the module ( $V_{o,set} \times I_{o,max}$ ). Please refer to the Application Note “Thermal Characterization Process For Open-Frame Board-Mounted Power Modules” for a detailed discussion of thermal aspects including maximum device temperatures.

### Heat Transfer via Convection

Increased airflow over the module enhances the heat transfer via convection. Thermal derating curves showing the maximum output current that can be delivered at different local ambient temperature ( $T_A$ ) for airflow conditions ranging from natural convection and up to 2m/s (400 ft./min) are shown in the Characteristics Curves section.

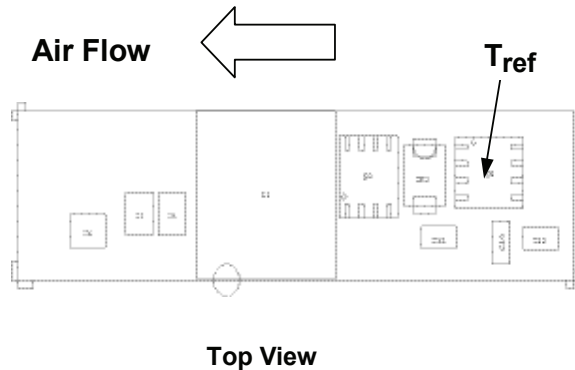


Figure 35.  $T_{ref}$  Temperature measurement location

### Post solder Cleaning and Drying Considerations

Post solder cleaning is usually the final circuit-board assembly process prior to electrical board testing. The result of inadequate cleaning and drying can affect both the reliability of a power module and the testability of the finished circuit-board assembly. For guidance on appropriate soldering, cleaning and drying procedures, refer to *Board Mounted Power Modules: Soldering and Cleaning Application Note*

### Through-Hole Lead-Free Soldering Information

The RoHS-compliant through-hole products use the SAC (Sn/Ag/Cu) Pb-free solder and RoHS-compliant components. They are designed to be processed through single or dual wave soldering machines. The pins have an RoHS-compliant finish that is compatible with both Pb and Pb-free wave soldering processes. A maximum preheat rate of 3°C/s is suggested. The wave preheat process should be such that the temperature of the power module board is kept below 210°C. For Pb solder, the recommended pot temperature is 260°C, while the Pb-free solder pot is 270°C max. Not all RoHS-compliant through-hole products can be processed with paste-through-hole Pb or Pb-free reflow process. If additional information is needed, please consult with your Lineage Power technical representative for more details.

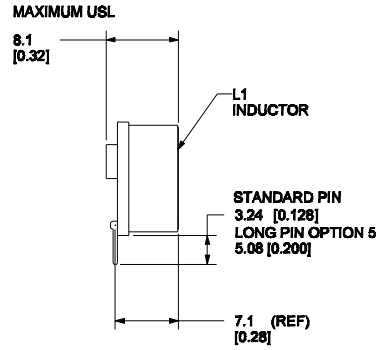
### Mechanical Outline

Dimensions are in millimeters and (inches).

Tolerances: x.x mm ± 0.5 mm (x.xx in. ± 0.02 in.) [unless otherwise indicated]

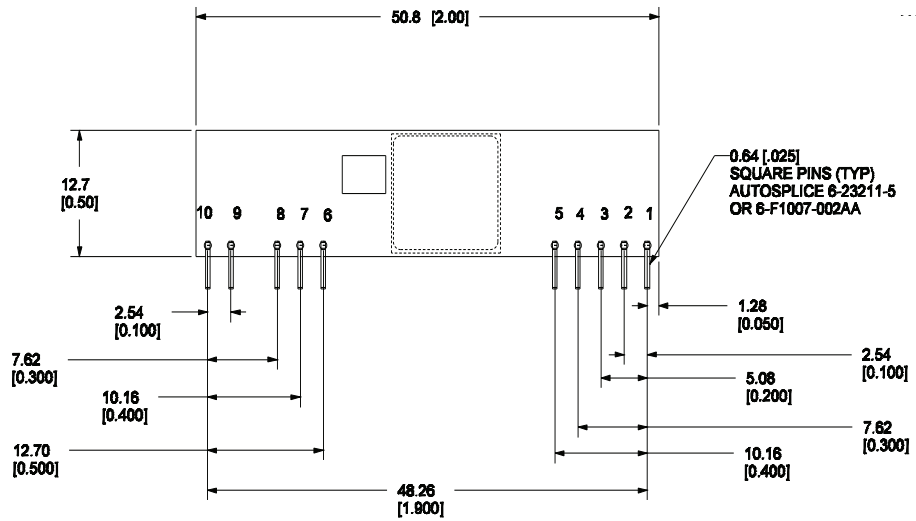
x.xx mm ± 0.25 mm (x.xxx in ± 0.010 in.)

#### Side View



#### Back View

PIN	FUNCTION
1	V <sub>o</sub>
2	V <sub>o</sub>
3	V <sub>o,sense</sub>
4	V <sub>o</sub>
5	GND
6	GND
7	V <sub>IN</sub>
8	V <sub>IN</sub>
9	TRIM
10	ON/OFF

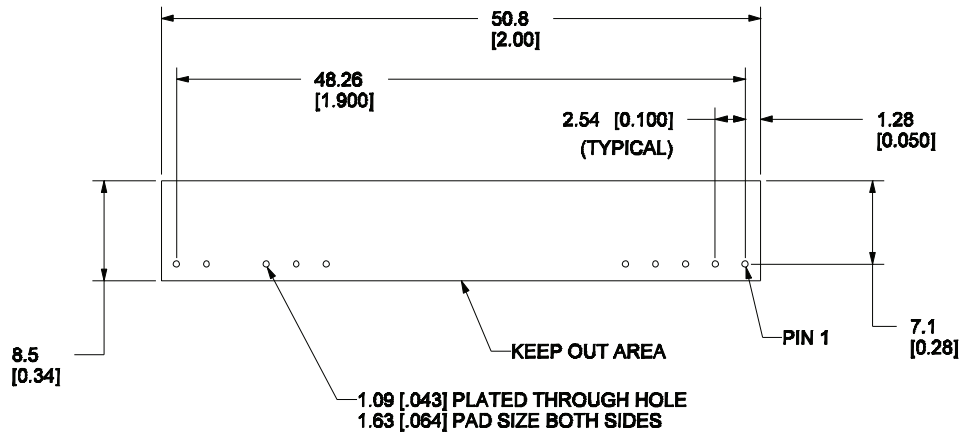


### Recommended Pad Layout

Dimensions are in millimeters and (inches).

Tolerances: x.x mm ± 0.5 mm (x.xx in. ± 0.02 in.) [unless otherwise indicated]

x.xx mm ± 0.25 mm (x.xxx in ± 0.010 in.)



RECOMMENDED HOLE PATTERN  
 COMPONENT-SIDE FOOTPRINT

Pin	Function
1	V <sub>o</sub>
2	V <sub>o</sub>
3	V <sub>o,sense</sub>
4	V <sub>o</sub>
5	GND
6	GND
7	V <sub>IN</sub>
8	V <sub>IN</sub>
9	TRIM
10	ON/OFF



## Ordering Information

Please contact your Lineage Power Sales Representative for pricing, availability and optional features.

**Table 2. Device Codes**

Device Code	Input Voltage Range	Output Voltage	Output Current	Efficiency 3.3V @full load	Connector Type	Comcodes
AXH010A0X3	3.0 – 5.5Vdc	0.75 – 3.63Vdc	10 A	95.0%	TH	108992046
AXH010A0X3Z	3.0 – 5.5Vdc	0.75 – 3.63Vdc	10 A	95.0%	TH	CC109101318

\* Remote sense feature is active and pin 6 is added with code suffix "3"

-Z refers to RoHS compliant Versions



**LINEAGE POWER**

**World Wide Headquarters**  
**Lineage Power Corporation**  
3000 Skyline Drive, Mesquite, TX 75149, USA  
**+1-800-526-7819**  
(Outside U.S.A.: **+1-972-284-2626**)  
**www.lineagepower.com**  
**e-mail: techsupport1@lineagepower.com**

**Asia-Pacific Headquarters**  
Tel: +65 6416 4283

**Europe, Middle-East and Africa Headquarters**  
Tel: +49 89 6089 286

**India Headquarters**  
Tel: +91 80 28411633

Lineage Power reserves the right to make changes to the product(s) or information contained herein without notice. No liability is assumed as a result of their use or application. No rights under any patent accompany the sale of any such product(s) or information.

© 2008 Lineage Power Corporation, (Mesquite, Texas) All International Rights Reserved.